

## MODEL IAMA - UNIVERSAL SIGNAL CONDITIONING MODULE

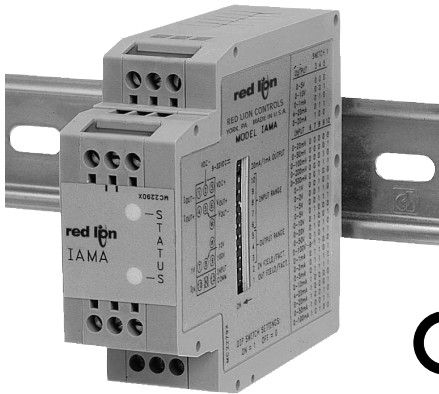

- 3-WAY ISOLATION OF ANALOG SIGNALS
- UNIVERSAL CONVERSION MODULE - INPUTS AND OUTPUTS SELECTED VIA DIP SWITCH SETTINGS
- OVER 100 INPUT AND OUTPUT ANALOG CONVERSION COMBINATIONS
- CHOOSE LINEAR OR SQUARE ROOT EXTRACTION MODEL
- ALL RANGES ARE FACTORY PRECALIBRATED. CUSTOM FIELD CALIBRATION IS AVAILABLE FOR ALL RANGES WHILE MAINTAINING THE FACTORY CALIBRATION FOR FUTURE USE
- 11 to 36 VDC AND 24 VAC MODULE POWER



UL Recognized Component,  
 File # E179259

### GENERAL DESCRIPTION

The IAMA – Universal Signal Conditioning Module Series can isolate and convert over 100 combinations of analog signal ranges. The IAMA3535 converts and transmits signals linearly proportional to the input, while the IAMA6262 transmits the scaled square root of the input signal. This allows the IAMA6262 to provide a signal that is linear to flow rate in applications utilizing a differential pressure transducer.

DIP switch range selection eliminates the need to order and stock different modules for each input and output signal range, and allows quick and convenient setup for over 100 standard signal conversions. By utilizing the Field mode of calibration, the user can customize the input and output scaling for odd applications, including reversal of the output relative to the input.

In addition to the conversion capabilities, the IAMA modules feature optically isolated Input/Output signal circuits and transformer isolated Power to Input, Power to Output circuits.

The modules' overall full scale accuracy typically exceed 0.05% depending upon range selection and scaling. The microprocessor based design provides ease of field scaling and the onboard E<sup>2</sup>PROM stores scaling values for future recall. Both models come factory precalibrated for all input and output ranges. Factory or custom field scaling can be selected by a simple mode switch change. The IAMA can be factory recalibrated in the field if desired.

The modules' environmental operating temperature range is -20°C to +65°C. DIN rail mounting saves time and panel space. The units are equipped with universal mounting feet for attachment to standard DIN style rails, including top hat profile rail according to EN50022 - 35x7.5 and 35 x 15 and G profile rail according to EN50035-G32.

### SAFETY SUMMARY

All safety related regulations, local codes and instructions that appear in the manual or on equipment must be observed to ensure personal safety and to prevent damage to either the instrument or equipment connected to it. If equipment is used in a manner not specified by the manufacturer, the protection provided by the equipment may be impaired.

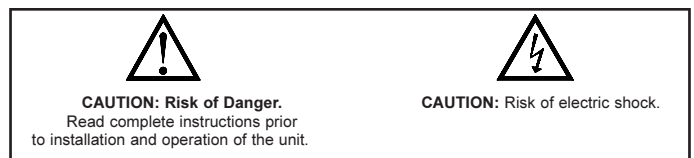

### ORDERING INFORMATION

MODEL NO.	DESCRIPTION	PART NUMBER
IAMA	Linear Universal Signal Conditioning Module	IAMA3535
	Square Root Universal Signal Conditioning Module	IAMA6262

### SPECIFICATIONS

- POWER:** 11 to 36 VDC, 3 W max. or 24 VAC, ±10%, 50/60 Hz, 4.8 VA max.
- INPUT/OUTPUT RANGES:** See Tables 2 and 3
- ZERO/SPAN ADJUSTMENTS:** Digital (DIP Switch Transition)
- MAX INPUT SIGNAL:**  
 Current Input: 110 mA DC, 1.1 VDC  
 Voltage Inputs: Terminal 7- 1 VDC +10%  
 Terminal 8- 10 VDC +10%  
 Terminal 9- 100 VDC +10%
- INPUT RESISTANCE:**  
 Current: 10 Ω  
 Voltage: > 100 K
- INPUT PROTECTION:** Surge suppressor diodes
- MAX OUTPUT CURRENT:**  
 Current Output: 22 mA  
 Voltage Output: 10 mA
- LOAD RESISTANCE:**  
 Current Output: ≤ 600 Ω  
 Voltage Output: ≥ 1 KΩ
- OUTPUT COMPLIANCE:**  
 Current: 4 to 20 mA, 0 to 20 mA: 12 V min (≤ 600 Ω)  
 0 to 1 mA: 10 V min (≤10 KΩ)  
 Voltage: 10 VDC across a min. 1 KΩ load (10 mA). Factory calibrated for loads of > 1 MΩ.
- ISOLATION LEVEL INPUT TO OUTPUT:** 1.5 kV @ 50/60 Hz, 1 min
- STEP RESPONSE:** To within 99% of full scale: 300 msec
- ACCURACY (INCLUDING LINEARITY):** Factory: ±0.1% of span max. for all ranges except 1 mA, 2 mA, and 20 mV. These ranges are accurate to ±0.2% of span max. All ranges can be field calibrated to 0.1% of span max.

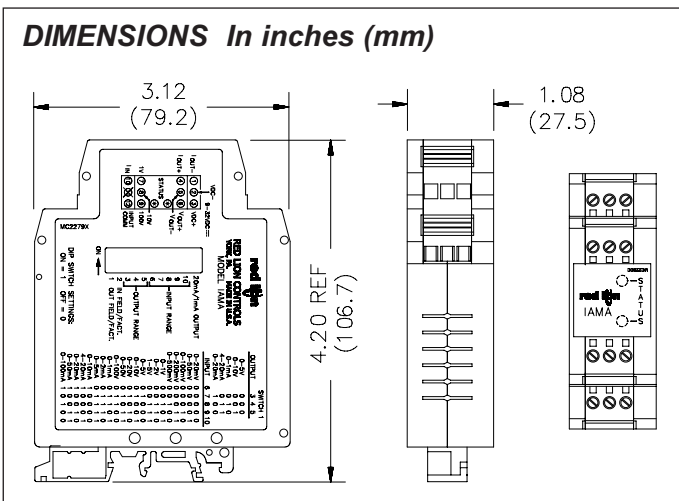

13. **RESOLUTION:** 0.01% full scale input, 0.01% full scale output
14. **ENVIRONMENTAL CONDITIONS:**  
**Operating Temperature Range:** -20 to +65 °C  
**Storage Temperature Range:** -40 to +85 °C  
**Operating and Storage Humidity:** 85% max. relative humidity (non-condensing) from -20 to +65 °C  
**Temperature Coefficient:** ± 0.01%/°C (100 PPM/°C) max.  
**Altitude:** Up to 2000 meters

15. **CERTIFICATIONS AND COMPLIANCES:**

**SAFETY**

UL Recognized Component, File #E179259, UL3101-1, CSA C22.2 No. 1010-1  
 Recognized to U.S. and Canadian requirements under the Component Recognition Program of Underwriters Laboratories, Inc.  
 IECCE CB Scheme Test Certificate # US/5141A/UL,  
 CB Scheme Test Report # 01ME11540-0702001  
 Issued by Underwriters Laboratories, Inc.  
 IEC 61010-1, EN 61010-1: Safety requirements for electrical equipment for measurement, control, and laboratory use, Part 1.

**ELECTROMAGNETIC COMPATIBILITY**

**Immunity to EN 50082-2**

Electrostatic discharge	EN 61000-4-2	Level 2; 4 Kv contact Level 3; 8 Kv air
Electromagnetic RF fields	EN 61000-4-3	Level 3; 10 V/m <sup>1</sup> 80 MHz - 1 GHz
Fast transients (burst)	EN 61000-4-4	Level 4; 2 Kv I/O <sup>2</sup> Level 3; 2 Kv power <sup>2</sup>
RF conducted interference	EN 61000-4-6	Level 3; 10 V/rms 150 KHz - 80 MHz
Simulation of cordless telephone	ENV 50204	Level 3; 10 V/m 900 MHz ± 5 MHz 200 Hz, 50% duty cycle

**Emissions to EN 50081-2**

RF interference	EN 55011	Enclosure class A Power mains class A
-----------------	----------	--

*Notes:*

- Self-recoverable loss of performance during EMI disturbance at 10 V/m:  
Analog output signal deviation less than 5% of full scale.  
For operation without loss of performance:  
Install power line filter, RLC #LFIL0000 or equivalent on DC power lines at unit.
- OR
- Criteria A: No loss of performance within the unit's specifications.  
Refer to EMC Installation Guidelines section of this bulletin for additional information.

16. **CONSTRUCTION:** Case body is green high impact plastic
17. **CONNECTIONS:** 14 AWG max
18. **MOUNTING:** Standard DIN top hat (T) profile rail according to EN50022 - 35x7.5 and 35 x 15 and G profile rail according to EN50035-G32.
19. **WEIGHT:** 4.5 oz. (127.57 g)

**BLOCK DIAGRAM**

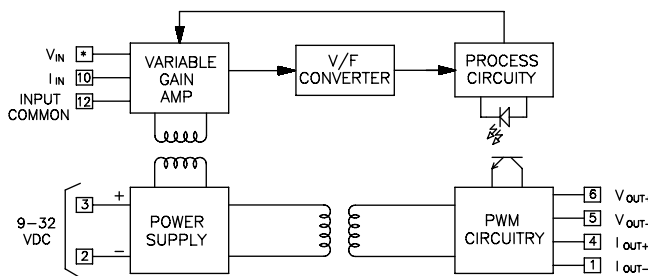

\* Terminal number is dependent on max. input voltage.

**MODULE ISOLATION**

IAMA modules feature "3-Way" Signal Isolation. The 3-Way isolation is a combination of optical and transformer isolation. The optical isolation provides common mode voltage (CMV) isolation up to 1.5 kV between the sensor input and the process signal output. The IAMA's power is isolated from the sensor signal input and the process signal output by a DC/DC transformer isolation circuit.

**OVERVIEW**

The IAMA3535 continuously monitors a voltage or current input and provides a linearly proportional voltage or current output, while the IAMA6262 transmits the scaled square root of the input signal. This allows the IAMA6262 to provide a signal that is linear to flow rate in applications utilizing a differential pressure transducer. Both units have two modes of operation known as Factory and Field modes. Factory mode is used when the default input and output ranges are suitable. Field mode can be independently selected for both the input and output, and allows the user to custom calibrate, or scale the signal. If Factory mode is selected, the IAMAs use factory presets for the selected input or output range. If Field mode is selected, the IAMAs can be custom scaled within a selected input or output range. Field mode also allows the IAMA to reverse its output in relation to its input.

The units are factory precalibrated for minimum and full scale for all input and output ranges. The factory calibration values are permanently stored in E<sup>2</sup>PROM and should not be changed in the field, unless unacceptable error or a factory checksum error occurs. See Factory Recalibration for details. Field scaling is achieved by applying minimum and full scale values from a calibration source and storing the values by a single DIP switch transition. Field scaling is available for all input and output ranges and the values are permanently stored in E<sup>2</sup>PROM until reprogramming occurs.

After field scaling, the IAMAs can be changed between Factory and Field modes for a particular range, which restores the respective setting. The Factory and Field E<sup>2</sup>PROM locations contain the same calibration values when the IAMA is received from the factory. Therefore, until the IAMA is field scaled, factory and field modes perform identically. See SCALING PROCEDURE for detailed instructions on field programming the IAMA.

The units can be scaled to any minimum scale and full scale values within the extent of the selected range. The closer together the minimum and full scale values are to each other, the less accurate the signal will be. For example, if the 0 to 1 V input range is selected, and the unit is scaled for 0 to 0.5 V, the signal has the same resolution as the 0 to 1 V range. Since this resolution will be two times the percentage of span for 0.5 V, more accuracy can be achieved by using the 0 to 0.5 V range.

The input may exceed the full scale value for the selected range by 10% of span, but the IAMA will not update the output beyond 10% over range.

The red and green LED's indicate the status of the modules during scaling and normal operation. Table 1, LED Indications, details the LED indications for various unit conditions.

The IAMA – Signal Conditioning Module Series is designed for use in industrial environments. Suppressor diodes protect both input and output circuits from wiring errors and transient high voltage conditions.

**INPUTS**

The IAMAs accept a full range of process signal inputs and isolate and convert these signals to common industrial control signals. The input signal combinations are configured by making specific DIP switch selections on the 10 position DIP switch.

**OUTPUTS**

As with the input choices, the process signal output of the modules is DIP switch selectable. A 1 position DIP switch is used to select between the 1 mA/20 mA output ranges. The maximum output current signal is 22 mA with ≤600 Ω output resistance and the maximum output voltage signal is 11 V with ≥1 KΩ output resistance.

**ZERO AND SPAN**

The input zero and span are set by first applying the minimum value then transitioning S1-2 to store that value. Next, the full scale value is applied and the DIP switch transition stores the value. The output scaling is performed in a similar manner but the output is driven to the desired minimum and full scale values by the calibration source applied to the input. S1-1 is used to store the minimum and full scale output values.

The span is defined by: span = (full scale - minimum scale).

**ILLEGAL RANGE SELECTIONS AND CHANGES**

The ranges should only be selected before power is applied. If an invalid input or output range is selected when power is applied the output is set to approximately 0 VDC and the red LED indicates the error according to Table 1. Power must be removed and the valid ranges selected for the IAMA to operate properly.

If S1 switches 3 through 10 are changed while the IAMA is operating, the red LED indicates a range change according to Table 1, LED Indications and the output goes to the previously stored range minimum scale value. Normal operation will be resumed if the switches are placed back in the previous positions or power is removed and restored.

## CHECKSUM ERRORS

A checksum is performed every time power is applied to the IAMA. If a checksum error occurs, the LEDs will indicate where the error occurred according to Table 1, LED Indications. Operation with a checksum error is not recommended but can be done in critical situations. If an error occurs, re-calibration of the field or factory ranges to be used must be performed.

If a field checksum error occurs, the IAMA will operate only in factory mode. If a factory checksum occurs, the IAMA will operate only in a previously calibrated field mode. Do not perform a field scaling until the factory checksum is cleared. Since a checksum error is a high priority LED indication, the LEDs will indicate the error until it is cleared. This will exclude other LED information.

**TABLE 1, LED INDICATIONS**

CONDITION	GREEN LED	RED LED
Normal Operation	On	Off
Scaling Mode	Alternate with Red	Alternate with Green
Under Range	Off	Slow Flash (0.8 sec rate)
Over Range	Off	Fast Flash (0.4 sec rate)
Invalid Range	Off	On
Illegal Range Change	Off	On
Factory Checksum	Off	On, short off
Field Checksum	On, short off	Off
User Factory Calibration	Fast Flash for 2 sec	Off

## GETTING STARTED

One method for the Input (1 or 2 below) should be configured, and one method for the Output (3 or 4 below) should be configured.

1. FACTORY preprogrammed settings for the Input, see Section 1.0
2. FIELD scaling method for the Input, see Section 2.0
3. FACTORY preprogrammed setting for the Output, see Section 3.0
4. FIELD scaling method for the Output, see Section 4.0

*Note: The ranges should only be changed while power is removed from the IAMA.*

**TABLE 2, OUTPUT RANGE SETTINGS**

	OUTPUT RANGE	RANGE DIP SWITCHES		
		3	4	5
VOLTAGE OUTPUTS	0 - 5 V	0	0	0
	0 - 10 V	0	0	1
CURRENT OUTPUTS	0 - 1 mA	0	1	0
	4 - 20 mA	0	1	1
	0 - 20 mA	1	0	0

*Note: DIP switch settings 0 = OFF 1 = ON*

**TABLE 3, INPUT RANGE SETTINGS**

	RANGE	RANGE DIP SWITCHES				
		6	7	8	9	10
INPUT VOLTAGE	0 - 20 mV	0	0	0	0	0
	0 - 50 mV	0	0	0	0	1
	0 - 100 mV	0	0	0	1	0
	0 - 200 mV	0	0	0	1	1
	0 - 500 mV	0	0	1	0	0
	0 - 1 V	0	0	1	0	1
	0 - 2 V	0	0	1	1	0
	1 - 5 V	0	0	1	1	1
	0 - 5 V	0	1	0	0	0
	0 - 10 V	0	1	0	0	1
	0 - 20 V	0	1	0	1	0
	0 - 50 V	0	1	0	1	1
	0 - 100 V	0	1	1	0	0
	INPUT CURRENT	0 - 1 mA	0	1	1	0
0 - 2 mA		0	1	1	1	0
0 - 5 mA		0	1	1	1	1
0 - 10 mA		1	0	0	0	0
4 - 20 mA		1	0	0	0	1
0 - 20 mA		1	0	0	1	0
0 - 50 mA		1	0	0	1	1
0 - 100 mA		1	0	1	0	0

*Note: DIP switch settings 0 = OFF 1 = ON*

## FIELD OR FACTORY MODE SELECTION

### SELECTING FIELD MODE (2 Methods):

1. Scale the input or output according to SCALING PROCEDURE 2.0 or 4.0
2. Before applying power, set the input or output (or both) field/factory switch to the up (field) position. Field calibration values will be restored upon power-up. If the IAMA has not been previously field calibrated, the E<sup>2</sup>PROM will contain the factory calibration values which will be restored.

### SELECTING FACTORY MODE (2 Methods):

1. Before applying power to the IAMA set the input or output (or both) field/factory switch to the down (factory) position. Factory calibration values will be restored upon power-up.
2. While power is applied to the IAMA and it is operating in the field input and/or output mode, set the desired field/factory switch(s) to the down (factory) position. The factory calibration values will be restored.

## EMC INSTALLATION GUIDELINES

Although this unit is designed with a high degree of immunity to ElectroMagnetic Interference (EMI), proper installation and wiring methods must be followed to ensure compatibility in each application. The type of the electrical noise, source or coupling method into the unit may be different for various installations. Cable length, routing, and shield termination are very important and can mean the difference between a successful or troublesome installation.

Listed below are some EMC guidelines for successful installation in an industrial environment.

1. Use shielded (screened) cables for all Signal and Control inputs. The shield (screen) pigtail connection should be made as short as possible. The connection point for the shield depends somewhat upon the application. Listed below are the recommended methods of connecting the shield, in order of their effectiveness.
  - a. Connect the shield only at the rail where the unit is mounted to earth ground (protective earth).
  - b. Connect the shield to earth ground at both ends of the cable, usually when the noise source frequency is above 1 MHz.
  - c. Connect the shield to common of the unit and leave the other end of the shield unconnected and insulated from earth ground.
2. Never run Signal or Control cables in the same conduit or raceway with AC power lines, conductors feeding motors, solenoids, SCR controls, and heaters, etc. The cables should be run in metal conduit that is properly grounded. This is especially useful in applications where cable runs are long and portable two-way radios are used in close proximity or if the installation is near a commercial radio transmitter.
3. Signal or Control cables within an enclosure should be routed as far away as possible from contactors, control relays, transformers, and other noisy components.
4. In extremely high EMI environments, the use of external EMI suppression devices, such as ferrite suppression cores, is effective. Install them on Signal and Control cables as close to the unit as possible. Loop the cable through the core several times or use multiple cores on each cable for additional protection. Install line filters on the power input cable to the unit to suppress power line interference. Install them near the power entry point of the enclosure. The following EMI suppression devices (or equivalent) are recommended:
  - Ferrite Suppression Cores for signal and control cables:
    - Fair-Rite # 0443167251 (RLC #FCOR0000)
    - TDK # ZCAT3035-1330A
    - Steward #28B2029-0A0
  - Line Filters for input power cables:
    - Schaffner # FN610-1/07 (RLC #LFIL0000)
    - Schaffner # FN670-1.8/07
    - Corcom #1VR3

*Note: Reference manufacturer's instructions when installing a line filter.*
5. Long cable runs are more susceptible to EMI pickup than short cable runs. Therefore, keep cable runs as short as possible.

## WIRING CONNECTIONS

All conductors should meet voltage and current ratings for each terminal. Also cabling should conform to appropriate standards of good installation, local codes and regulations. It is recommended that power supplied to the unit be protected by a fuse or circuit breaker. When wiring the unit, use the numbers on the label to identify the position number with the proper function. Strip the wire, leaving approximately 1/4" (6 mm) of bare wire exposed. Insert the wire into the terminal, and tighten the screw until the wire is clamped tightly.

## POWER AND OUTPUT CONNECTIONS

### Power

Primary power is connected to terminals 2 and 3 (labeled VDC- and VDC+). For best results, the Power should be relatively “clean” and within the specified variation limits. Drawing power from heavily loaded circuits or from circuits that also power loads that cycle on and off, should be avoided.

### Current Output

Wiring for a current output is connected to terminals 1 (IOUT-) and 4 (IOUT+). DIP switch S2 should be set for the desired full scale output current. (20 mA = ON; 1 mA = OFF).

### Voltage Output

Wiring for a voltage output is connected to terminals 5 (VOUT-) and 6 (VOUT+).

**Note:** Although signals are present at voltage and current outputs at the same time, only the selected range is in calibration at any one time.

**Example:** A 0 to 10 VDC output is selected. The voltage level present at the voltage output terminals is in calibration, but the signal appearing at the current output terminals does not conform to any of the current output ranges.

## INPUT CONNECTIONS

### Current Input

Wiring for a current input is connected to terminals 10 (IIN) and 12 (INPUT COMMON).

### Voltage Input

Wiring for a voltage input is connected to terminal 12 (INPUT COMMON) and one of the three available voltage terminals listed below, depending on maximum input voltage.

Terminal 7: 1 VDC max.

Terminal 8: 10 VDC max.

Terminal 9: 100 VDC max.

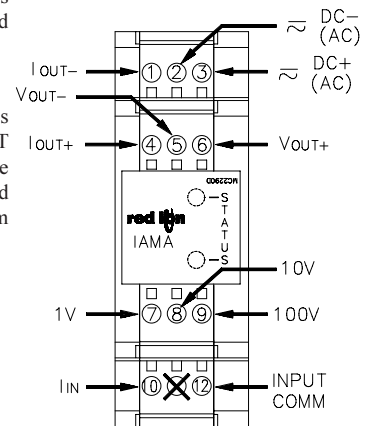

## SCALING PROCEDURE

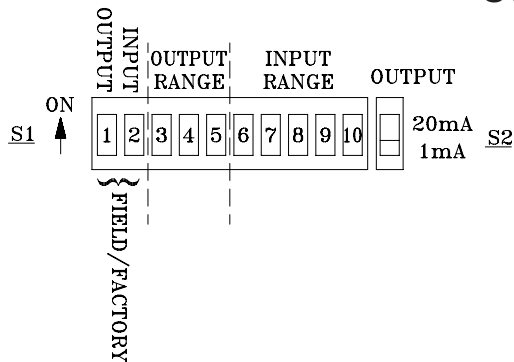

The accuracy of the IAMA is dependent on the accuracy of the calibration source and the voltage or current meter used in the scaling process.

If an out of range (see Table 1 for LED indications) or illegal (full scale less than minimum scale) scaling is attempted, the factory calibration values will be stored in place of the field values. This will prohibit erroneous operation of the IAMA. The scaling procedure will have to be repeated.

The final storage of the zero and full scale values to E<sup>2</sup>PROM is not done until the last transition of the mode/calibration DIP switches (S1-1 or S1-2). Therefore, the scaling can be aborted any time before the full scale value is saved. This is accomplished by cycling power to the IAMA. The IAMA will restore the factory or previous field scaling values at power up depending on the setting of the DIP switches. See Mode Selection for more detailed instructions for selecting factory and field modes at power up. See Table 2 and 3 for the input and output range DIP switch settings.

### 1.0 INPUT SET-UP USING FACTORY CONFIGURATION

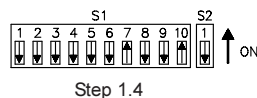
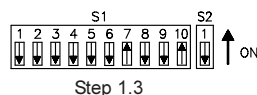
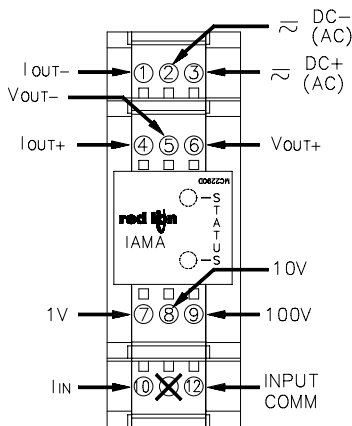

- 1.1 Remove power.
- 1.2 Connect signal wires to the correct input terminals based on the maximum signal input.
  - Terminal 7: max. signal input 1 VDC
  - Terminal 8: max. signal input 10 VDC
  - Terminal 9: max. signal input 100 VDC
  - Terminal 10: max. signal input 100 mA
  - Terminal 12: signal common
- 1.3 Set Input Range switches (S1 switches 6 through 10) to the desired Input Range (See Table 3). (0 to 10 VDC range shown).
- 1.4 Set Input Field/Fact. switch (S1 switch 2) to the off position.
- 1.5 Apply power to the IAMA.
  - Solid illumination of Green LED if signal is within the minimum and maximum limits of the selected input range.*
  - Slow blinking of Red LED if signal decreases below minimum limit of selected input range.*
  - Rapid blinking of Red LED if signal increases above maximum limit of selected input range.*
- 1.6 Input set-up complete. Go to Step 3.0 or Step 4.0.

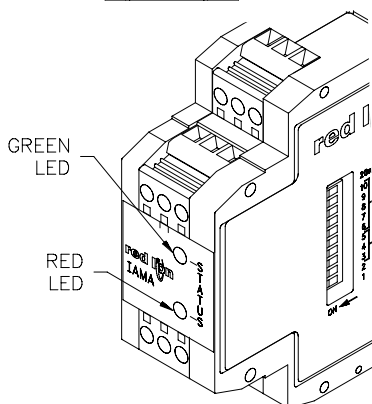

## 2.0 INPUT SCALING USING FIELD CONFIGURATION

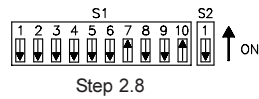
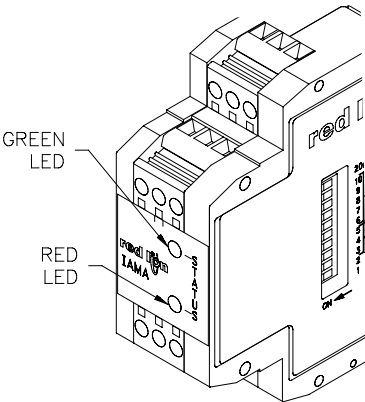
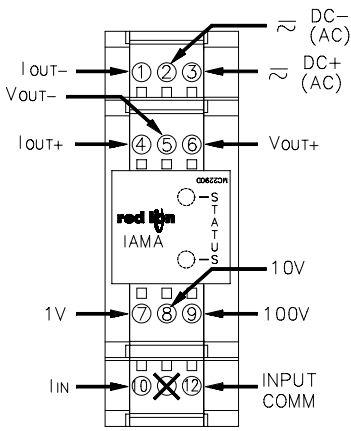

- 2.1 Remove power.
- 2.2 Connect signal source to the correct input terminals based on the maximum signal input.
  - Terminal 7: max. signal input 1 VDC
  - Terminal 8: max. signal input 10 VDC
  - Terminal 9: max. signal input 100 VDC
  - Terminal 10: max. signal input 100 mA
  - Terminal 12: signal common
- 2.3 Set Input Range switches (S1 switches 6 through 10) to the desired input range (See Table 3). Select the lowest possible range that will support the desired maximum signal. Example: if the desired span is 20 mV to 85 mV, the best range selection is 0 to 100 mV. The 0 to 200 mV will also suffice, but the accuracy will be reduced. (0 to 10 VDC range shown).
- 2.4 Set Input Field/Fact. switch (S1 switch 2) to the off position.
- 2.5 Apply power to the IAMA and allow a warm up period of five minutes. Follow the manufacturer's warm up procedure for the calibration source.
- 2.6 Set Input Field/Fact. switch (S1 switch 2) to the on position. *The Red and Green LEDs will alternately blink.*
- 2.7 Apply desired minimum scale signal.
- 2.8 Set Input Field/Fact. switch (S1 switch 2) to the off position. *The Red and Green LEDs will alternately blink. If the signal is equal or below the minimum limit of the selected range, the Red LED blinks slowly and the Green LED turns off. Removing power aborts scaling, begin at Step 2.1.*
- 2.9 Apply maximum scale input. *The Red and Green LEDs will alternately blink.*
- 2.10 Set Input Field/Fact. switch (S1 switch 2) to the on position. *Red LED extinguishes and Green LED becomes solid. Your scaled values are now saved and recalled if the Input Field/Fact. switch (S1 switch 2) is in the on position when power is applied. Red LED will blink slowly if signal is equal to or below minimum limit and blinks rapidly if signal increases above maximum limit.*
- 2.11 Input scaling complete. Go to Step 3.0 or Step 4.0.

## 3.0 OUTPUT SET-UP USING FACTORY CONFIGURATION

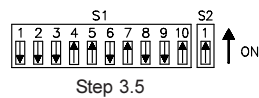
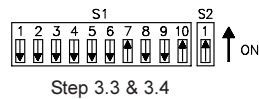
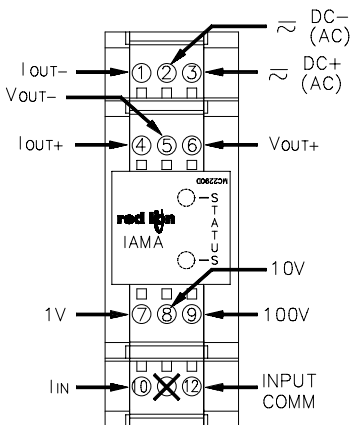

- 3.1 Remove power.
- 3.2 For voltage output values, go to Step 3.4  
For current output values, continue at Step 3.3
- 3.3 Set 20 mA/1 mA switch (S2) to desired full scale output. (20 mA - on; 1 mA - off)
- 3.4 Set Output Field/Fact. switch (S1 switch 1) to the off position.
- 3.5 Set Output Range switches (S1 switches 3, 4, and 5) to the desired Output Range (See Table 2). (4 to 20 mA range shown)
- 3.6 Connect external device to appropriate IAMA output terminals.
  - Terminal 6: + Voltage
  - Terminal 5: - Voltage
  - Terminal 4: + Current
  - Terminal 1: - Current
- 3.7 Apply power to the IAMA and allow a warm up period of five minutes. Output set-up complete.

## 4.0 OUTPUT SCALING USING FIELD CONFIGURATION

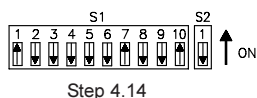
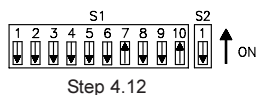
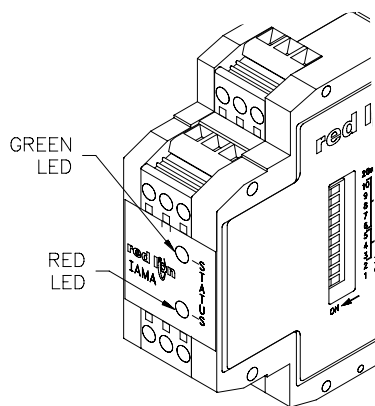
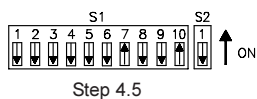
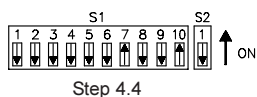
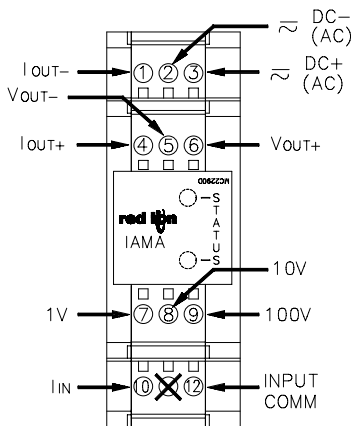

- 4.1 Remove power.
- 4.2 For voltage output scaling, go to Step 4.4.  
For current output scaling, continue at Step 4.3.
- 4.3 Set 20 mA/1 mA switch (S2) to desired full scale output.  
(20 mA - on; 1 mA - off)
- 4.4 Set Output Field/Fact. switch (S1 switch 1) to the off position.
- 4.5 Set Output Range switches (S1 switches 3, 4, and 5) to the desired Output Range (See Table 2). Select the lowest possible range that will support the desired full scale output. Example: if the desired span is 1 V to 4 V, the best range selection is 0 to 5 V. (0 to 5 VDC range shown)
- 4.6 Connect volt or current meter to appropriate IAMA output terminals.  
Terminal 6: + Voltage  
Terminal 5: - Voltage  
Terminal 4: + Current  
Terminal 1: - Current
- 4.7 An input signal is required to complete output scaling. If previous scaled input is used (completed in Step 2.0), Input Field/Fact. switch (S1 switch 2) and Input Range switches (S1 switches 6 through 10) must remain in the same positions. If another signal source is used, set Input Field/Fact. switch (S1 switch 2) to off position and Input Range switches (S1 switches 6 through 10) to the desired input range (See Table 3).
- 4.8 Connect input signal source to the correct input terminals based on the maximum signal input.  
Terminal 7: max. signal input 1 VDC  
Terminal 8: max. signal input 10 VDC  
Terminal 9: max. signal input 100 VDC  
Terminal 10: max. signal input 100 mA  
Terminal 12: signal common
- 4.9 Apply power to the IAMA and allow a warm up period of five minutes.
- 4.10 Set Output Field/Fact. switch (S1 switch 1) to the on position.  
*The Red and Green LEDs will alternately blink.  
If Red LED blinks slowly, increase signal until Red and Green LEDs alternately blink.*
- 4.11 Adjust the input signal until the desired \* minimum output level is displayed on the volt or current meter.  
*The Red and Green LEDs will alternately blink.*
- 4.12 Set Output Field/Fact. switch (S1 switch 1) to the off position.  
*The Red and Green LEDs alternately blink.  
If the signal is equal to or below the minimum limit of the selected range, the Red LED blinks slowly and the Green LED turns off. Removing power aborts scaling. Start over at Step 4.1.*
- 4.13 Adjust the input signal until the desired \* maximum output level is displayed on the volt or current meter.
- 4.14 Set Output Field/Fact. switch (S1 switch 1) to the on position.  
*Red LED extinguishes and Green LED becomes solid. Your scaled values are now saved and will be recalled if the Output Field/Fact. switch (S1 switch 1) is in the on position when power is applied.*
- 4.15 Output scaling is complete.

\* If the minimum output is higher than the maximum output the module reverses its output behaviour accordingly.

## RECALIBRATING FACTORY STORED VALUES



**WARNING:** Read the complete procedure at least once before attempting to recalibrate the factory values. This procedure should only be performed due to factory checksum error or unacceptable error. This procedure should be performed by qualified technicians using accurate calibration equipment.

The following list outlines conditions that are unique to factory recalibration:

1. Unlike the field scaling procedures, there are no software under and over range indications while performing a factory recalibration. Therefore, care must be taken to insure the selected range extents are not exceeded. The minimum scale and full scale calibration values must be set to the extents of the range being calibrated.  
For example: If the Input Range DIP switches are set for the 4-20 mA range, minimum scale must be set at 4 mA, and full scale must be set at 20 mA.
2. At least one input calibration must be completed before calibrating any output range. When calibrating the input voltage range, it is recommended that a range above 1 V be used to provide better accuracy.
3. If multiple input or output ranges are to be calibrated, DO NOT REMOVE POWER TO CHANGE THE RANGE. Place the appropriate Field/Fact. DIP switch; S1-1 for outputs, and S1-2 for inputs to the down position, and set the remaining DIP switches for the range to be calibrated. *Note: Be sure to change the terminal wiring to match the Input or Output range DIP switch settings before performing the calibration procedure. Set calibration source to 0 V or 0 mA before changing wiring.*

## INPUT RECALIBRATION

1. To enter the factory calibration mode, set switches S1-1 and S1-2 down, S1-3 through S1-5 up, and S1-6 through S1-10 down.
2. Connect a signal source to the correct input terminals based on the maximum signal input to be calibrated. If an output range will be calibrated after the input range is calibrated, connect a voltage or current meter to the appropriate output terminals at this time.
3. Apply power to the IAMA. After the version number indication, the green LED will flash rapidly for 2 seconds indicating the factory calibration mode has been entered. Allow the IAMA to warm up for 5 minutes minimum and follow the manufacturer's warm up procedure for the calibration source.
4. Set the Input Range DIP switches to the desired input range according to Table 3.
5. Complete Steps 2.6 through 2.10 of Input Scaling Using Field Configuration. *Note: There will be no over or under range indication of the LED's during this procedure, so use care not to exceed the range extents.*
6. If an output is to be calibrated, continue from #2 of Output Recalibration below. If no further input or output calibration is to be completed, return S1-1 and S1-2 to the down position and remove power from the IAMA. Apply power and check for accurate operation of the newly calibrated range or ranges.

## OUTPUT RECALIBRATION

1. Complete 1 through 5 of the input recalibration procedure for at least one range.
2. For current output, set 20 mA/1 mA switch (S2) to desired full scale output. (20 mA - on; 1 mA - off)
3. Set Output Field/Fact. switch (S1 switch 1) to the off position.
4. Set the Output Range DIP switches to the desired output range according to Table 2.
5. Complete Steps 4.10 through 4.14 of Output Scaling Using Field Configuration. *Note: There will be no over or under range indication of the LED's during this procedure, so use care not to exceed the range extents.*
6. If no further calibration is to be completed, return S1-1 and S1-2 to the down position and remove power from the IAMA. Apply power and check for accurate operation of the newly calibrated range or ranges.

## TROUBLESHOOTING

For further technical assistance, contact technical support at the appropriate company numbers listed.

## INSTALLATION

The unit is equipped with a universal mounting foot for attachment to standard DIN style mounting rails, including G profile rail according to EN50035 - G32, and top hat (T) profile rail according to EN50022 - 35 x 7.5 and 35 x 15. The unit should be installed in a location that does not exceed the maximum operating temperature and provides good air circulation. Placing the unit near devices that generate excessive heat should be avoided.

### G Rail Installation

To install the IAMA on a "G" style DIN rail, angle the module so that the upper groove of the "foot" catches under the lip of the top rail. Push the module toward the rail until it snaps into place. To remove a module from the rail, push up on the bottom of the module while pulling out and away from the rail.

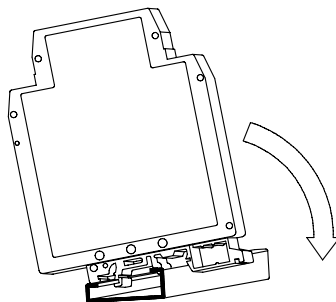

### T Rail Installation

To install the IAMA on a "T" style rail, angle the module so that the top groove of the "foot" is located over the lip of the top rail. Push the module toward the rail until it snaps into place. To remove a module from the rail, insert a screwdriver into the slot on the bottom of the "foot", and pry upwards on the module until it releases from the rail.

